

Boîtiers en Delrin usinés pour joncs



Les boîtiers sont livrés complets :
vis, écrous de fixation, vis de réglage,
et contre-plaque.

Machined Delrin batten retainers for rod battens

The retainers are supplied with
tension & mounting screws,
and back plate.

















Jonc
Rod
mm mm

| | | | | |
|--|---------------|--|----|-------|
|  | 105667 | Boîtier de chute avec vis de réglage en alu (vis de fixation en alu) Leach retainer | 22 | 18-20 |
| | 105678 | Boîtier de guindant (vis de fixation en alu) Luff retainer | 10 | 18-20 |
|  | 105672 | Boîtier de chute 150 x 75 mm, avec vis de réglage en alu et vis de fixation en inox Leach retainer 150 x 75 mm | 22 | 22 |
| | 105673 | Boîtier de chute 150 x 75 mm, avec vis de réglage en alu et vis de fixation en inox Leach retainer 150 x 75 mm | 22 | 28 |
|  | 105682 | Boîtier de guindant (vis de fixation en inox) Luff retainer | 10 | 22 |
| | 105683 | Boîtier de guindant (vis de fixation en inox) Luff retainer | 10 | 28 |

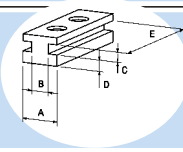

Accessoires de boîtiers SDA

Accessories for SDA batten retainers

| | | | A | B | C | D | E |
|---|---------------|--|------|------|-----|-----|----|
| | | | mm | mm | mm | mm | mm |
|  | 103007 | Coulisseau (type Francespar) pour boîtiers 105719 & 105720 Slide for 105719 & 105720 batten retainers | 16 | 4 | 4 | 4 | 53 |
| | 103006 | Coulisseau (type Selden) pour boîtiers 105719 & 105720 Slide for 105719 & 105720 batten retainers | 14 | 4 | 6,4 | 4 | 53 |
| | 103008 | Coulisseau pour boîtiers 105719 & 105720 Slide for 105719 & 105720 batten retainers | 16 | 7,5 | 4 | 4 | 55 |
| | 103009 | | 19 | 5 | 4 | 4 | 53 |
| 103010 | 24 | | 11 | 5 | 5 | 53 | |
|  | 105705 | Coulisseau-ralingue en Ertalon à chape Ertalon slide with toggle | 10 | 4 | 7 | 5 | 55 |
| | 103275 | | 14 | 4 | 7 | 7 | 55 |
|  | 105919 | Coulisseau-ralingue chape double en Ertalon Ertalon slide with double toggle | 14 | 4 | 7 | 7 | 55 |
|  | 103024 | Coulisseau-ralingue en Ertalon à sangler Ertalon slide for strap | 10 | 4 | 7 | 5 | 55 |
| | 105918 | | 14 | 4 | 7 | 7 | 55 |
|  | 106076 | Axe inox pour boîtiers de guindant à jonc, taraudés à 10 mm pour coulisseau-ralingue chape double 105919 S.S. joint for rod batten retainers, 10 mm thread for double toggle slide no. 105919 | | | | | 24 |
|  | 105540 | Axe inox pour boîtiers de guindant à jonc, taraudés à 10 mm S.S. joint for rod batten retainers, 10 mm thread | | | | | 24 |
| | 103013 | | | | | | 32 |
| | 103012 | Axe inox pour boîtiers réversibles 105718 & 105717, taraudés à 12 mm S.S. joint for 105718 & 105717 batten retainers, 12 mm thread | | | | | 24 |
|  | 103034 | Coulisseau articulé en inox pour patin à 3 trous S.S. articulated slide | 19 | | | | 60 |
|  | 103035 | Coulisseau à sangler en inox pour patin à 3 trous S.S. slide for strape | 19 | | | | 60 |
|  | 103014 | Cardan GM pour patin à 3 trous et boîtiers taraudés à 10 mm S.S. articulated joint for retainers 10 mm thread | 20 | | | 4 | 70 |
|  | 105725 | Patin en Ertalon à 3 trous (vis inox fournies) Ertalon slide, three holes (with inox screws) | 16,8 | 6,8 | 5 | 5,2 | 71 |
| | 103017 | | 10,8 | 9 | 5 | 6 | 70 |
| | 103018 | | 24 | 11,2 | 6,2 | 6,8 | 75 |
| | 103022 | | 30 | 16 | 6 | 7,2 | 75 |



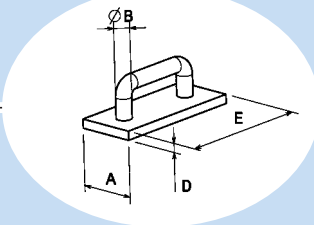

| | | | A | B | C | D | E | |
|---|---|--|---|--------------------|------------------|-------------------|-----------------|----------------------|
| | | | mm | mm | mm | mm | mm | |
|  | 103015 | Cardan PM pour patin à 2 trous et boîtiers taraudés à 10 mm Articulated joint for retainers, 10 mm thread | | | | | | |
|  | 103019 103020 103021 | Patin en Ertalon à 2 trous pour cardan 103015 (vis fournies) Ertalon slide for 103015, two holes (with screws) |  | 16,7 19,6 24 | 7 9,4 11,3 | 5,3 5,2 6,2 | 5 6,2 6,8 | 60,5 60,5 60,5 |
|  | 93435 | Vis de réglage de tension en alu 13 mm pour boîtier 103193 (avec vis blocage) Tension screw for 103193 retainer (with locking screw) | | | | | | |
| | 93436 | Vis de réglage de tension en alu 17 mm pour boîtier 103195 (avec vis de blocage) Tension screw for 103195 retainer (with locking screw) | | | | | | |
| | 93437 | Vis de réglage de tension en alu 22 mm pour boîtier 103197 & 103198 (avec vis de blocage) Tension screw for 103197 & 103198 retainer (with locking screw) | | | | | | |

Coulisseaux / Slides





| | | | A | B | C | D | E | |
|---|--|---------------------------------------|--|----------------------------|---------------------------|----|--------------------|------------------------|
| | | | mm | mm | mm | mm | mm | |
|  | 103040 103041 103042 103043 | Coulisseau plastique Plastic slide |  | 15 17,7 21,7 13,8 | 7,4 8,8 10,7 4,2 | | 3 3,5 4 5 | 30 34 36,6 30 |
|  | 103039 103036 103037 103038 | Coulisseau inox Plastic slide inox | | 16 15,7 19 23 | 5 5 5 5 | | 3 3 3 | 37 45 45 45 |

Lattes plates et joncs à voile / Sail flat & rod battens

Formulation en verre et résine polyester / Made of polyester resin and glass.







| | | |  |  |  |
|---|---|---|---|---|---|
| | | | mm | mm | mm |
|  | 103226 103227 103228 103230 | Latte plate (par longueur de 6 m) Flat batten (in 6-m section) | 15 30 40 | 3 24 3 | 2,5 |
|  | 103217 103218 103219 103220 103221 103222 103223 | Jonc (par longueur de 6 m) Rod batten (in 6-m section) | | | 8 10 12 14 16 18 20 |

Accessoires pour lattes & joncs / Sail flat & rod battens accessories

| | | |  |  |  |
|---|---|--|---|---|---|
| | | | mm | mm | mm |
|  | 103025 103026 103027 103028 103029 103030 103031 103032 103033 | Cartouche de réduction pour jonc Rod batten reduction | | | 6/10 8/10 8/13 10/13 12/17 14/17 14/21 16/21 18/21 |
|  | 103055 103056 103057 103058 103059 103060 | Embout plastique de latte Plastic end for strap and flat batten | 9 15 24 30 40 15 | | |













mm

| | | | |
|---|---------------|--|----|
|  | 103240 | Collier en polyamide noir (visserie fournie) Black polyamide clamp (bolt & nut supplied) | 22 |
| | 103241 | Collier en polyamide noir (visserie fournie) Black polyamide clamp (bolt & nut supplied) | 23 |
|  | 103242 | Embout en polyamide noir Black polyamide end plug | 22 |
| | 103243 | Embout en polyamide noir Black polyamide end plug | 23 |
|  | 103244 | Platine en polymamide noir (visserie fournie) Black polyamide plate (bolt & nut supplied) | |
|  | 103246 | Bouton de Tenax Tenax button | |
|  | 103245 | Embase Tenax à 2 trous Tenax plate with 2 holes | |
|  | 103247 | Embase Tenax à vis Tenax screw | |
|  | 103074 | Crochet de taud en laiton nickelé Nickel plated brass lacing button | |
| | 103075 | Crochet de taud en plastique blanc White plastic lacing button | |

Accessoires de voilerie

Sailmaker accessories



| | | | |
|---|---------------|--|-----|
|  | 103072 | Anneau à coudre Sew on eye | |
| | 103073 | Crochet à coudre Sew on hook | |
|  | 93438 | Manille à visser GM avec sa vis Large screw on shackle with its screw | |
| | 93439 | Manille à visser PM avec sa vis Small screw on shackle with its screw | |
|  | 100682 | Manille à frapper GM Large snap on shackle | |
| | 100683 | Manille à frapper PM Small snap on shackle | |
|  | 103125 | Coinceur en nylon pour nerf de chute Nylon leech line cleat | |
|  | 103126 | Coinceur en nylon pour nerf de chute avec contre plaque Nylon leech line cleat with backplate | 2-5 |
| | 103127 | Coinceur en nylon pour nerf de chute avec contre plaque & rivets Nylon leech line cleat with rivets & backplate | |
|  | 103129 | Protection pour coinqueur 103125 Shield for 103125 | |
|  | 103130 | Coinceur en nylon pour nerf de chute avec contre plaque & rivets Nylon leech line cleat with rivets & backplate | 0-3 |
|  | 103131 | Coinceur en nylon profilé pour nerf de chute, avec contre plaque Nylon leech line cleat with backplate | 2-6 |
|  | 103132 | Coinceur en aluminium pour nerf de chute Aluminium leech line cleat | 3-6 |
|  | 103128 | Contre plaque pour coinqueur alu 103132 Backplate for 103132 aluminium cleat | |
|  | 103133 | Coinceur en aluminium pour nerf de chute avec contre plaque Aluminium leech line cleat with backplate | 3-6 |